



# Trio RCE

G20/G25/G25.3 (natural gas)



Instructions for installation

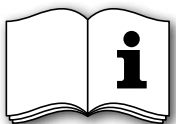

Please retain this document carefully



## Contents

	page
Preface	2
1. Introduction	3
2. CE Declaration	3
3. SAFETY	3
3.1 General	3
3.2 Regulations	3
3.3 Precautions / safety instructions during installation	3
4. Instructions	4
5. Removing the packaging	4
6. Installation	4
6.1 Regulations	4
6.2 Type of gas	4
6.3 Gas connection	4
6.4 Placement of the appliance	5
6.5 Flue gas discharge / combustion air supply system	5
6.6 Connecting gas	9
6.7 Setting the appliance	9
6.8 Placing the wood set	10
6.9 Panes	10
7. Wireless remote control	11
7.1 Receiver	11
7.2 Setting the communication code	12
7.3 Alternative operation	12
8. Final check	13
8.1 Gastightness	13
8.2 Gas pressure / pre-pressure	13
8.3 Ignition pilot and main burner	13
8.4 Flame picture	14
9. Maintenance	14
10. Delivery	14
11. Storing	15
Appendix 1 Parts included with the delivery	18
Appendix 2 Technical data	19
Appendix 3 Parts	20
Appendix 4 Figures	21

## Preface

DRU, a manufacturer of gas heating appliances, develops and produces products that comply with the highest quality, performance and safety requirements. This guarantees that the user will be able to enjoy using his product for many years to come. This appliance has a CE marking, which means that it complies with the essential requirements of the European gas appliance directive. As an installer, you must be competent in the field of atmospheric gas heating. Two manuals are supplied with the appliance: the installation manual and the user manual. Installation and maintenance of the appliance should be performed by a professional certified expert with proven knowledge and demonstrable competence in this field. A professional expert takes all technical aspects such as heat output, gas connection and electricity into account, as well as the flue gas discharge requirements.

The installation manual will give you the information you need to install the appliance in such a way that it will operate properly and safely. If the installation instruction is not clear, national/local regulations must be observed. This manual discusses the installation of the appliance and the regulations that apply to the installation. In addition, you will find technical data for the appliance and information on maintenance, any malfunctions that might occur and their possible causes.

***Please carefully read and use this installation manual.***

The following symbols are used in the manual to indicate important information:



**Work to be performed**



**!Tip Suggestions and recommendations**



**!Caution You will need these instructions to prevent problems that might occur during installation and/or use.**



**!Caution**

**You need these instructions to prevent fire, personal injury or other serious damages.**

***After delivery, you should give the user manual and this installation manual to the user.***

## 1. Introduction

The Trio is a freestanding atmospheric gas heating appliance. This version of the Trio is suitable for natural gas. It is not possible to make the appliance suitable for a different type of gas by using a so-called conversion set.

The Trio is a closed appliance. A closed appliance does not extract the combustion air from the living environment, but from outside. This is done through a combined flue gas discharge system / combustion air supply system. In this concentric system the outer pipe serves as air supply and the inner pipe as flue gas discharge.

This system can be installed through the wall, or through the roof.

The concentric system can be supplied in the colour of the appliance.

The appliance is supplied with a wireless remote control that works on batteries.

## 2. CE declaration

DRU declares that company internal measures guarantee that appliances produced by DRU meet the essential requirements and guidelines of the regulation concerning gas-fired appliances and the accompanying standards. This declaration loses its validity if changes are made to the appliance without written permission from DRU. The instructions in the manuals must also be observed at all times. A copy of the CE test certificate can be downloaded via [www.druservice.com](http://www.druservice.com).

Product:	Gas-fired heating appliance
Type:	Trio RCE
Product identification number:	0063BS3770
Conformity assessment agency:	Kiwa Netherlands B.V. (0063) Wilmersdorf 50 Postbus 137 7300 AC, Apeldoorn
EC regulations:	2016/426/EU
EC directives:	2014/35/EU, 2014/30/EU
Applied harmonized standards:	EN613:2022, NEN-EN-613/A1

DRU verwarming B.V.  
Postbus 1021, 6920 BA Duiven  
Ratio 8, 6921 RW Duiven  
[www.drufire.com](http://www.drufire.com)

Duiven, 05-04-2022



R.P. Zantinge, Managing director

## 3. SAFETY



Caution

### 3.1 General

- Carefully read this chapter on safety, before you start performing installation or maintenance work;
- Please observe the general regulations and the precautions/safety instructions in this manual.

### 3.2 Regulations

Please install the appliance in accordance with the applicable national, local and constructional (installation) regulations.

### 3.3 Precautions / safety instructions during installation

Carefully follow the following precautions/safety regulations:

- ▬ you should only install and maintain the appliance if you are a competent installer in the field of atmospheric gas heating;
- ▬ do not make any changes to the appliance;
- ▬ only use the flue gas discharge / combustion air supply system supplied by DRU;
- ▬ place the appliance at a distance of at least 40 mm from the back wall;
- ▬ do not cover the appliance and the discharge material and/or do not wrap it in an insulation blanket or any other material;
- ▬ always place the appliance and/or the discharge pipes at a minimum distance of 500 mm from combustible objects or materials;
- ▬ only ever use the supplied wood set;
- ▬ place the wood set exactly as described;
- ▬ make sure the pilot burner and the space around it is kept free;
- ▬ avoid dirt in gas pipes and connections;
- ▬ check the connections for gastightness before using the appliance;
- ▬ avoid blocking of the pressure equalization hatch on top of the appliance;
- ▬ check whether the pressure equalization hatch fits well onto the sealing surface;

- ⇒ do not ignite the appliance until it is fully installed;
- ⇒ replace torn or broken panes.
- ⇒ The appliance was designed for atmospheric and heating purposes. This means that all visible surfaces, including the glass pane, can become hotter than 100C°. It is recommended to always place a protective grating in front of the appliance when there are children, elderly people or handicapped persons in the same room as the appliance. If it is possible that vulnerable people are regularly present in the room with no supervision, a fixed guard should be mounted around the appliance.



- Caution**
- In case of broken or torn glass panes, the application may not be used.
  - Protect the appliance against dust and moisture created during the building process!

## 4. Instructions

- Observe the following items during installation in order to guarantee a proper and safe operation of the appliance:
- ⇒ avoid that the ignition cable runs over and/or alongside metal parts, in order to prevent weakening of the spark;
  - ⇒ avoid damaging the panes during removal/placing;
  - ⇒ clean the panes before you use the appliance, in order to prevent dirt from burning in the glass.

## 5. Removing the packaging

- Note the following items when removing the packaging:
- ⇒ remove all packaging materials
  - ⇒ Check the appliance for damages during transport;
  - ⇒ If necessary, contact DRU Service;
  - ⇒ Take the parts box and the wood set from the space behind the door at the bottom of the appliance.
- In appendix 1 / table 5 you can see which parts you should have after removing the packaging.
- ⇒ Remove both woodscrews from the bottom plate connecting the appliance to the platform.

- Caution** The glass pane(s) is/are made of a ceramic material. Very small irregularities in the glass pane(s) cannot be avoided, but are within the required quality standards.



- Caution** Keep plastic bags away from children.

- ⇒ Contact DRU Service if you do not have all the parts after you finished removing the packaging;
- ⇒ Dispose packaging in accordance with local regulations.

## 6. Installation

Read this manual carefully to ensure a proper and safe operation of the appliance.

- !Caution** Install the appliance in the order described in this chapter.

### 6.1 Regulations

- Please install the appliance in accordance with the applicable national, local and constructional (installation) regulations;
- Observe the regulations/instructions in this manual.

### 6.2 Type of gas

The type plate indicates for which type of gas, gas pressure and for which country this appliance is intended. The type plate can be found behind the door on the back wall of the space at the bottom of the appliance.



- Caution**
- Check whether the appliance is suitable for the type of gas and the gas pressure used at the location.
  - Do not make any changes to the appliance.

#### 6.2.1 Reconstruction to different type of gas

If you want to convert this appliance into a different type of gas, please contact DRU's service department and ask what is possible. Reconstructions should only be performed by authorized gas installers.

### 6.3 Gas connection

Place a gas tap in the gas connection, close to the appliance.



- Caution**
- Make sure there is no dirt in the gas pipes and connections.
  - No soldering may take place at the flexible gas hose(s), as this could cause leaks.

The following requirements apply to the gas connection:

- use a gas pipe with the correct dimensions, so that no pressure loss can occur;
- the gas tap must be approved (in the EU this will be the CE mark);
- you should always be able to reach the gas tap.

## 6.4 Placement of the appliance

Place the appliance as follows:

-  **Caution** - Always place the appliance and/or the discharge pipes at a minimum distance of 500 mm from combustible objects or materials;
- ▢ Determine the location of the appliance; the dimensions can be found in Fig. 1, see Appendix 4;
  - ▢ Provide a gas connection at the location. For details, see section 6.3;
  - ▢ Make a duct for the flue gas discharge/combustion air supply system with the following diameters. For details, see section 6.5.
    - Ø160 mm for a wall duct through incombustible material;
    - Ø250 mm for a wall duct through combustible material;
    - Ø160 mm for a roof duct through incombustible material;
    - Ø250 mm for a roof duct through combustible material.

- ▢ Place the appliance on its destined location.
-  **Caution** - Place the appliance at a distance of at least 40 mm from the back wall;
- Do not cover the appliance and the discharge material and/or do not wrap it in an insulation blanket or any other material.

## 6.5 Flue gas discharge / combustion air supply system

### 6.5.1 General

The appliance is of the C11/C31/C91 type.

The appliance is connected to a combined flue gas discharge/combustion air supply system, hereafter referred to as the concentric system.

The passage to the outside can be made with a wall duct (see section 6.5.2) or with a roof duct (see section 6.5.3).

If necessary, you can also use an existing discharge channel (see section 6.5.4).

-  **Caution** - Only use the concentric system supplied by DRU (Ø100 / Ø150 mm). This system was tested in combination with the appliance; DRU cannot guarantee a proper and safe operation of other systems and cannot accept liability for these systems;
- For connecting to an existing chimney flue you should only use the installation set supplied by DRU.

The concentric system is constructed from (the discharge stump of) the appliance.

If structural circumstances require that the concentric system is placed first, the appliance can later be connected with a telescopic pipe piece.

- !Tip** DRU does not recommend placing the telescopic piece, because this visible pipe piece cannot be supplied in colour and does not really combine well with the appliance.

### 6.5.2 Application with wall duct

#### 6.5.2.1 Construction of concentric system with wall duct

The concentric system with wall duct has to comply with the following conditions (see Appendix 4, Fig. 2):

- First, a concentric pipe of at least 1 meter should be connected vertically to the appliance;
- The total vertical pipe length can have a maximum of 4 meters;
- On the vertical part a bend of 90° is connected;
- The total horizontal pipe length can have a maximum of 3 meters (wall duct excluded).

Under these conditions you should not install the restrictor slide; the air inlet guide will not be placed.

#### 6.5.2.2 Placing concentric system with wall duct

Place the concentric system as follows:

- ▢ Build the system up from (the connection stump of) the appliance.
-  **Caution** - Maintain a distance of at least 50 mm between the outside of the concentric system and the walls and/or the ceiling;
- Use heat-resistant isolation material when passing through combustible material;
  - The rosette (mounting inner plate) of the wall duct is too small to seal the Ø 250 mm opening when passing through combustible material. That is why you should first apply a sufficiently large heat-resistant intermediate plate to the wall. Then, the rosette is mounted on the intermediate plate.

- !Caution** Some heat-resistant isolation materials contain volatile components that will spread an unpleasant smell for a prolonged time; these are not suitable.

- ➡ Remove the top plate from the appliance; this plate is loose;
- ➡ Remove the cover plate by unscrewing the 2 parkers (see Appendix 4, Fig. 2);
- ➡ Place a lacquered pipe piece on the appliance;
- ➡ Apply a lacquered clip binding with silicon sealing ring onto the connection between appliance and pipe piece;
- ➡ Refit the cover plate with the 2 parkers;
- ➡ Place the top plate carefully onto the appliance, so that the lacquered pipe piece will not be damaged;
- ➡ If necessary, connect the vertical (lacquered) concentric pipe pieces;
- ➡ Connect the lacquered bend;
- ➡ If necessary, connect the horizontal (lacquered) concentric pipe pieces;
- ➡ On each connection, apply a (lacquered) clip binding with silicon sealing ring;
- ➡ Use a parker to fix the clip binding to the pipe on locations that are unreachable after installation;
- ➡ Attach the concentric system with sufficient fastening brackets, so that the weight is not resting on the appliance. Observe the following;
  - Place the first fastening bracket 0.5 metre from the appliance, at the most.
  - Place a fastening bracket maximum 0.1 metre from each bend, if the bends are more than 0.25 metre away from each other. If two bends are closer to one another than 0.25 metre, 1 fastening bracket between these bends will be sufficient.
  - At least every 1 metre, place a fastening bracket at slanted and horizontal sections.
  - At least every 2 metres, place a fastening bracket at vertical sections.
- ➡ Determine the remaining length of the wall duct;
- ➡ Make sure the wall duct has the right dimensions.
- !Caution - Make sure that the right insertion length is maintained;
  - Place the wall duct with the groove/folded seam at the top;
  - Make sure the horizontal concentric pipe pieces are sloping towards the wall duct, in order to prevent rain water from entering.
- ➡ Mount the rosette (mounting inner plate); if necessary, on a heat resistant intermediate plate when passing through combustible material;
- ➡ Attach the wall duct from the outside with four screws in their respective holes.

### 6.5.3 Application with roof duct

#### 6.5.3.1 Construction of concentric system with roof duct

The concentric system with roof duct has to comply with the following conditions:

- The construction of the chosen system has to be allowed. (See the procedure described below);
- First, a concentric pipe of at least 1 meter should be connected vertically to the appliance.

Depending on the construction, the appliance is set by means of the baffle and/or the air inlet guide.

In the following procedure you can see how the allowability of a concentric system can be determined and which settings are needed.

- ➡ Determine the following data:

- 1) The number of bends required (no distinction is made between 45° and 90° bends);
- 2) The total number of meters of horizontal pipe length;
- 3) The total number of meters of vertical and/or sloping pipe length.

These data will help you determine whether the concentric system is allowed by using Table 1 for G25/G25.3 and Table 3 for G20.

In Table 2 you can read for G25/G25.3 and G20 which setting is required for the appliance.

Follow the procedure described below:

- ➡ In the first 2 columns of Table 1/Table 3, search the number of bends required and the total horizontal pipe length;
  - ➡ In the 3rd column of Table 1/Table 3, search the total vertical and/or sloping pipe length.
- If you end up in a box with the letter A, B, C, D or E, the concentric system chosen by you is allowed.
- ➡ Use Table 2 to determine which conditions apply for the baffle and/or the air inlet guide (for placing/setting see section 6.7).

#### Examples G25/G25.3

To clarify, we will give 2 examples for gas G25/G25.3, to determine the allowability of a concentric system and the conditions for setting the appliance.

In Table 1 the route to be followed is indicated by arrows. The result is indicated by an underlined letter (= allowed) or a dash "-" (= not allowed).

**Example 1**

- 1) 2 bends
  - 2) 3 meters horizontal
  - 3) 8 meters vertical/sloping
- Construction of this concentric system is allowed.  
→ Situation D applies for setting the appliance

**Example 2**

- 1) 3 bends
  - 2) 4 meters horizontal
  - 3) 9 meters vertical/sloping
- Construction of this concentric system is not allowed.

**Table 1: Relation construction concentric system / setting appliance**

G25/G25.3	total number of meters horizontal pipe length	total number of meters vertical and/or sloping pipe length											
		1	2	3	4	5	6	7	↓8	↓9	10	11	12
no bends	0	B	C	D	D	D	E	E	E	E	E	E	E
2 bends	0	A	A	B	C	D	D	D	E	E	E	E	E
	1		A	A	B	C	D	D	D	E	E	E	
	2			A	A	B	C	D	D	D	E		
→	3				A	A	B	C	D	D			
	4					A	A	B	C				
	5												
3 bends	0		A	A	B	C	D	D	D	E	E	E	E
	1		A	A	A	B	C	D	D	D	D	D	
	2			A	A	A	B	C	D	D	D		
	3				A	A	A	B	C	D			
→	4					A	A	A	B	D			
	5												
4 bends	0		A	A	A	B	C	D	D	D	E	E	E
	1		A	A	A	A	B	C	D	D	D	E	
	2			A	A	A	A	B	C	D	D		
	3				A	A	A	A	B	B			
	4					A	A	A	A				
	5												
5 bends	-												

■ = construction is not allowed

**Table 2: Conditions for setting the appliance**

Situation	Air inlet guide	Baffle	Distance restriction
A	NO	YES	65 mm
B	NO	YES	50 mm
C	NO	YES	40 mm
D	NO	YES	33 mm
E	YES	YES	33 mm

**Examples G2o**

To clarify, we will give 2 examples for Gas 20, to determine the allowability of a concentric system and the conditions for setting the appliance.

In Table 3 the route to be followed is indicated by arrows. The result is indicated by an underlined letter (= allowed) or a dash "-" (= not allowed).

**Example 1**

- 1) 2 bends
  - 2) 3 meters horizontal
  - 3) 8 meters vertical/sloping
- Construction of this concentric system is allowed.  
→ Situation C applies for setting the appliance

**Example 2**

- 1) 3 bends
  - 2) 4 meters horizontal
  - 3) 9 meters vertical/sloping
- Construction of this concentric system is not allowed.

**Table 3: Relation construction concentric system / setting appliance**

G2o	total number of meters horizontal pipe length	total number of meters vertical and/or sloping pipe length											
		1	2	3	4	5	6	7	↓8	↓9	10	11	12
no bends	0	B	C	C	C	C	E	E	E	E	E	E	E
2 bends	0	A	A	B	C	C	C	C	E	E	E	E	E
	1		A	A	B	C	C	C	C	E	E	E	
	2			A	A	B	C	C	C	C	E		
→	3				A	A	B	C	<u>C</u>	C			
	4					A	A	B	C				
	5												
3 bends	0		A	A	B	C	C	C	C	E	E	E	E
	1		A	A	A	B	C	C	C	C	E	E	
	2			A	A	A	B	C	C	C	C		
	3				A	A	A	B	C	C			
→	4					A	A	A	B				
	5												
4 bends	0		A	A	A	B	C	C	C	C	E	E	E
	1		A	A	A	A	B	C	C	C	C	E	
	2			A	A	A	A	B	C	C	C		
	3				A	A	A	A	B	C			
	4					A	A	A	A				
	5												
5 bends	-												

■ = construction is not allowed

**6.5.3.2 Placing concentric system with roof duct**

The roof duct can end in a sloping and a flat roof.

The roof duct can be supplied with an adhesive plate for a flat roof or with a universally adjustable tile for a sloping roof.

Place the concentric system as follows:

**Build the system up from (the connection stump of) the appliance.**



- Maintain a distance of at least 50 mm between the outside of the concentric system and the walls and/or the ceiling;
- Use heat-resistant isolation material when passing through combustible material.



**!Caution** Some heat-resistant isolation materials contain volatile components that will spread an unpleasant smell for a prolonged time; these are not suitable.

- ➡ Remove the top plate from the appliance; this plate is loose;
- ➡ Remove the cover plate by unscrewing the 2 parkers (see Appendix 4, Fig. 3);
- ➡ Place a lacquered pipe piece on the appliance;
- ➡ Apply a lacquered clip binding with silicon sealing ring onto the connection between appliance and pipe piece;
- ➡ Refit the cover plate with the 2 parkers;
- ➡ Place the top plate carefully onto the appliance, so that the lacquered pipe piece will not be damaged;
- ➡ Connect the horizontal (lacquered) concentric pipe pieces and, if necessary, the bends;
- ➡ On each connection, apply a (lacquered) clip binding with silicon sealing ring;
- ➡ Use a parker to fix the clip binding to the pipe on locations that are unreachable after installation;
- ➡ Attach the concentric system with sufficient fastening brackets, so that the weight is not resting on the appliance.

Observe the following;

- Place the first fastening bracket 0.5 metre from the appliance, at the most.
- Place a fastening bracket maximum 0.1 metre from each bend, if the bends are more than 0.25 metre away from each other. If two bends are closer to one another than 0.25 metre, 1 fastening bracket between these bends will be sufficient.
- At least every 1 metre, place a fastening bracket at slanted and horizontal sections.
- At least every 2 metres, place a fastening bracket at vertical sections.

➡ Fasten a roof terminal with anchor cables, if it protrudes more than 1,5 metres above the terminal.

➡ Determine the remaining length of the roof duct;

➡ Make sure the roof duct has the right dimensions.

**!Caution** Make sure that the right insertion length is maintained.

➡ Connect the roof duct to the concentric pipes.

**!Caution** - Make sure that the universal tile fits well with the surrounding tiles;

- Make sure that the adhesive plate fits well onto the flat roof.

### 6.5.4 Connection of existing chimney flue

It is possible to connect the appliance to an existing channel.

A flexible SS pipe is placed in the chimney for discharging flue gases. The surrounding space is used to supply combustion air.

The following requirements apply when connecting to an existing chimney flue:

- only allowed when used in combination with the special DRU chimney installation set.

The installation regulation is also supplied;

- the dimensions should be at least 150 x 150 mm;
- the vertical length has a maximum of 12 meters;
- the horizontal length has a maximum of 3 meters;
- the existing chimney flue has to be clean;
- the existing chimney flue has to be closed.

For adjusting the appliance, the same conditions/instructions apply as for the concentric system described above.

### 6.6 Connecting gas

Use the following procedure when connecting the gas, see section 6.3 Gas connection:

➡ If necessary, blow through the gas pipe;

➡ Connect the gas pipe with gas tap to the gas control block.

**!Caution** - You can find the gas control block behind the door in the space at the bottom of the appliance;

- Do not turn the gas tap when connecting the gas pipe.

➡ Bleed the gas pipe.

### 6.7 Setting the appliance

The appliance has to be set in such a way that it works correctly in combination with the discharge system.

For that purpose it is possible to install a baffle and/or an air inlet guide. For the conditions, see section 6.5.2.1, for application with wall duct and section 6.5.3.1, Table 2, for application with roof duct.

#### 6.7.1 Baffle (R)

**!Caution** The restrictor slide should be placed in the correct manner. Therefore, accurately observe the instructions

The baffle (R) is supplied separately.

Follow the procedure below when placing the baffle:

➡ Remove the front pane as indicated in section 6.9.1;

- ▣ Place the baffle (see Appendix 4, Fig. 4);
- ▣ Use the template to set the distance of the restriction (see Appendix 4, Fig. 5) as follows:
  - A distance of 33 mm means that the baffle is closed to a maximum level;
  - A distance of 40, 50 and 65 mm is set by using a template.
- ▣ Fix the baffle by using the socket cap screw (S).

### 6.7.2 Air inlet guide (L)

The air inlet guide (L) is supplied separately.

Follow the procedure below for installing the air inlet guide (see Appendix 4, Fig. 6):

- ▣ Remove the front pane as indicated in section 6.9.1;
  - ▣ Remove the tray surrounding the burner (M) from the appliance;
  - ▣ Place the air inlet guide;
  - ▣ Place the tray surrounding the burner (M) back in the appliance.
- !Caution** Do not throw away the air inlet guides, you may need them in the future.

## 6.8 Placing the wood set

The appliance is supplied with a wood set.



**!Caution** Strictly observe the following instructions to prevent unsafe situations:

- only ever use the supplied wood set;
- place the wood set exactly as described;
- make sure the pilot burner and the space around it are kept free from objects (see Appendix 4, Fig. 7);
- make sure that the slot between the burner tray and the tray surrounding the burner is kept free from objects.
- make sure that the vermiculite's fine dust does not get on the burners.

### 6.8.1 Wood set

The wood set consists of vermiculite (see Appendix 4, Fig. 8), chips (see Appendix 4, Fig. 9) and a number of blocks.

- ▣ Fill the burner tray with vermiculite; equally spread the vermiculite (see Appendix 4, Fig. 14).

**!Caution** - You can influence the flame image by moving the vermiculite, yet  
- the burner deck has to remain covered with vermiculite in order to prevent that the life expectancy of the burner is reduced

- ▣ Fill the tray around the burner with chips; equally spread the chips.



**!Caution** Do NOT place chips over the slot, around the burner.

- ▣ Identify blocks A up to F by using Fig. 10, see Appendix 4.

**!Tip** Use the burn stains on the blocks for identification.

- ▣ First place blocks A and B (see Appendix 4, Fig. 11).



**!Caution** - Place block A in such a way that the pilot flame and flame opening are not covered. Fig. 11, see Appendix 4, shows how it should be done, and Fig. 12, see Appendix 4, shows how it should not be done

- ▣ Then place blocks C up to F (see Appendix 4, Fig. 13).



**!Caution** The logs should not completely cover the burner pattern, because:

- the main burners will not ignite properly; which could result in unsafe situations;
- the appliance will become filthy more quickly, as a result of soot;
- the flame picture will be affected.

## 6.9 Panes

### 6.9.1 Front pane

After placing the wood set you can place the front pane as described below.

- !Caution**
- Avoid/remove fingerprints on the pane, as they will burn into the glass.
  - Avoid damages when removing/placing the glass pane.
  - Make sure the sealing tape at the edges of the glass pane is not damaged during removal.

#### 6.9.1.1 Removing the front pane

When removing the front pane, you should observe the instructions below; (see Appendix 4, Fig. 15 to 18)

- ▣ Open the door;
- ▣ Unscrew the 6 parkers of the glass strip at the sides by using the socket spanner supplied;
- ▣ Remove the glass strips;
- ▣ Unscrew the 3 parkers of the upper glass strip;
- ▣ Hold the pane and remove the upper glass strip;
- ▣ Remove the pane from the slot at the underside.

#### 6.9.1.2 Placing the front pane

Placing the front pane will take place in reverse order of the removal procedure described above.

- !Caution** Do not screw the parkers on too tight, to prevent breaking and/or slipping: tight=tight.

## 6.9.2 Side panes

The side panes should be removed in case of torn or broken panes.

### 6.9.2.1 Removing the side pane

Follow the steps below for removing:

- ▣ Carefully remove the top plate from the appliance, so that the lacquered pipe piece will not be damaged. The top plate is loose;
- ▣ Slide the housing upwards at the side (see Appendix 4, Fig. 19);
- ▣ Remove this part of the housing;
- ▣ Unscrew the 3 parkers at the top by using the socket spanner;
- ▣ Hold the pane and remove the glass strip;
- ▣ Remove the pane from the slot at the underside.

### 6.9.2.2 Placing the side pane

Placing the side pane will take place in reverse order of the removal procedure described above.

**!Caution** Do not screw the parkers on too tight, to prevent breaking and/or slipping: tight=tight.

## 7. Wireless remote control

The appliance is supplied with a wireless remote control.

Ignition, controlling the flame height and switching off are performed by a remote control that operates a receiver in the control box.

User Manual, chapter 4, Command/control, describes the operation of the appliance including the way the remote control works.

**!Caution** Do not ignite the appliance before the gas and discharge connections have been fully installed, first observe the procedure described in chapter 8.3.

Below, we will describe how the receiver is connected.

### 7.1 Receiver

The receiver should be connected to the appliance, before the batteries are installed.

Follow the procedure below (see Appendix 4, Fig. 21):

- ▣ Slide the brown plug of the connecting cable onto the back of the receiver's printed circuit board.
- ▣ Connect the white plug to the gas control block.
- !Tip** The plugs have different sizes that correspond with the connectors.
- ▣ Connect the cables of thermocouple 1 to the receiver; (see Appendix 4, Fig. 21, arrow B).
- !Tip**
  - The size of the eye corresponds with the size of the screw;
  - The colours of eye and screw also correspond.
- ▣ Connect the ignition cable to the receiver; (see Appendix 4, Fig. 21, arrow A).
- ▣ Connect power:
  - a) When using batteries, see section 7.1.1 below;
  - b) When using an adapter:
    - connect it to the receiver; (see Appendix 4, Fig. 21, arrow C);
    - insert the plug into the wall socket.
- ▣ Place the receiver in the control box, as indicated on Fig. 22 (o), see Appendix 4.
- ▣ Bend the antenna out of the clips; see Appendix 4, Fig. 21, arrow D and Fig. 22.
- ▣ Set the antenna straight.

**!Caution**

- Do not place the antenna too close to the ignition cable and/or metal parts (for the correct position, see Appendix 4, Fig. 22);
- Do not place the ignition cable over and/or along metal parts: this will weaken the spark;
- Do not lay the ignition cable over the receiver. this could damage the receiver;
- Avoid dust on or in the receiver: cover it when performing work.

### 7.1.1 Placing / replacing the batteries

Follow the procedure below when placing the batteries:

- ▣▣▣▣ **Open the door of the stove.**
- ▣▣▣▣ **Pick up the receiver.**
- ▣▣▣▣ **Slide the cover off.**
- ▣▣▣▣ **Place or remove the 4 penlite (AA type) batteries.**

- !Caution**
- Avoid a short circuit between the batteries and metal objects/parts;
  - Observe the "+" and "-" poles of the batteries and the holder;
  - Use alkaline batteries.

- ▣▣▣▣ **Slide back the cover.**
- ▣▣▣▣ **Place back the receiver.**

**!Caution** Batteries are regarded as "small chemical waste" and may therefore not be disposed with the household rubbish.

### 7.2 Setting the communication code

Prior to putting the application into operation, a communication code must be set between the remote control and the receiver. If the receiver or the remote control are replaced, a new code will have to be set.

Follow the procedure described below:

- ▣▣▣▣ **If necessary, place the batteries in the receiver's battery holder; see section 6.1.1.**
- ▣▣▣▣ **If necessary, place the 9V block battery in the remote controle; see User Manual.**
- ▣▣▣▣ **Hold down the reset button on the receiver, until you hear two consecutive sound signals (see Appendix 4, Fig. 24).**
- ▣▣▣▣ **After the second, longer signal, let go of the reset button.**
- ▣▣▣▣ **Press the 'small flame' button on the remote control for 20 seconds, until you hear two short sound signals: this is the confirmation of a good communication.**

▣ Small Flame

▣ Large Flame

### 7.3 Alternative operation

Appliances made with an electronic ignition and radio remote control can be connected to an alternative external control system (e.g. Domotics). For this purpose, there are 4 connection points at the side of the receiver (see Appendix 4, Fig. 20). For connecting an external control unit, you will need a "Domotics connection cable for GV60". Consult DRU's service website.

The following contacts are possible:

- Ignition: connect both contacts 1 + 3, for one second (if there is a 2nd thermocouple, the appliance should burn at full power for at least 20 sec. before the required position can be chosen).
- Flame high(er): briefly close contact 1 once per step, or 12 seconds for the highest position.
- Flame low(er) until switch-off (pilot flame remains on): briefly close contact 3 once per step, or 12 seconds for the lowest position.
- Completely switching off the appliance (pilot flame included): close all three contacts 1 + 2 + 3, for one second.

The appliance will always continue to respond to the radio remote control supplied with it. The external control system is able to use one of the two modes of this remote control.

#### 1. Manual mode

This mode of the remote control is passive and will not take any action unless it is operated. The external control system is able to control the functions for high/low position, ignition and switching off.

**!Tip** If the external control system has an intelligent clock function and/or thermostat function, the remote control supplied with the appliance should have the manual mode in order to prevent interruption of these functions.

#### 2. Clock/thermostat mode

This mode of the remote control is active and will be responsible for the clock function and thermostat function. The external control system is able to control the functions for high/low position, ignition and switching off.

**!Tip**

- If the appliance is switched off (the pilot flame included) manually or by one of the safeguards, ignition of the appliance will be blocked for a period of 3 minutes for reasons of safety.
- If it is no longer possible to operate the appliance with the external control system, you must switch it off and then switch it on again with the supplied remote control.

## 8. Final check

In order to check whether the appliance is working properly and safely, you must perform the following checks before the appliance is used.

### 8.1 Gastightness



**Caution** All connections must be gastight.

**Caution** The gas control block can be subjected to a maximum pressure of 50 mbar.

☛ Check the connections for gastightness.

### 8.2 Gas pressure / pre-pressure

The burner pressure is set at the factory; see type plate. It is not necessary to check the burner pressure.

The pre-pressure in house installations, however, should be checked, as they can vary.

☛ Check the pre-pressure; see Appendix 4, Fig. 23 for the measuring nipple on the gas control block;

☛ Contact the gas company if the pre-pressure is not correct.

### 8.3 Ignition pilot and main burner

For igniting the pilot and main burner, see the User Manual, chapter 4, Operation.

**Caution** Always wait 5 minutes after the pilot flame has gone out, before you re-ignite the appliance.

#### 8.3.1 First ignition of the appliance after installation or adjustments

**Caution** After installation, or after work has been performed, you should ignite the appliance for the first time without the glass window. If necessary, bleed the gas pipe.

Follow the procedure described below:

☛ If required, remove the glass window;

☛ Start the ignition procedure according to chapter 4 in the User Manual;

☛ If the pilot flame does not ignite:

- repeat the ignition procedure until the pilot burner ignites;

- consult the malfunction search diagram (Chapter 11) if this does not happen after a few attempts;

☛ After igniting the pilot flame, the main burner will ignite during the ignition procedure;

☛ Check whether the main burner continues to burn;

☛ If the main burner does not continue to burn:

- repeat the ignition procedure until the main burner continues to burn

- consult the malfunction search diagram (Chapter 11) if this does not happen after a few attempts;

☛ Switch off the appliance;

☛ Clean the glass pane before using it for the first time, as described in the user manual.

☛ Then mount the glass pane as described in section 6.9.

☛ Repeat the ignition procedure a few times and perform the checks described in chapter 8.3.2;

☛ From now on, the pilot flame should ignite smoothly.

☛ Clean the glass pane after burning for the first time, as described in the user manual.

**Caution** - During the ignition process, you are not allowed to operate control button B on the gas control manually.

- Always wait 5 minutes after the pilot flame has gone out, before you re-ignite the appliance.

- You are not allowed to turn the pilot flame lower by using the settings on the gas control.

#### 8.3.2 Main burner

**Caution** - The pilot burner should ignite the main burner within a couple of seconds, and without popping.

- The main burner(s) must cross the full burner smoothly and without popping and continue to burn.

☛ Check operation of the main burner from a cold condition (pilot flame off):

☛ After opening the gas valve, the main burner should burn within a few seconds.

**Tip** When the gas valve is opened, the motor will start to run; this is audible.

The flame picture and a good flame transfer can only be properly judged if the glass window is installed.

Use the malfunction search diagram (Chapter 11) if the ignition of the main burner does not comply with the above-mentioned requirements.

## 8.4 Flame picture

The flame picture can only really be assessed when the appliance has been burning for several hours. Volatile components from paint, materials, etc., which evaporate in the first hours, will affect the flame picture.

- ▢ Check whether the flame picture is acceptable.
- ▢ Consult the malfunction search diagram (Chapter 11) if the flame picture is not acceptable.

## 9. Maintenance

Once a year the appliance should be checked, cleaned and, if necessary, repaired by a competent installer in the field of atmospheric gas heating.

Check at least whether the appliance is working properly and safely.



**Caution**

- Close the gas tap when performing maintenance work;
- Check the gastightness after repair;
- After replacing the thermocouple you should first tighten the swivel of the gas control block by hand and then give it another quarter turn with a suitable spanner.
- **SS-absolutely do not clean the concentric system (internally) with a steel brush or metal sponge, for example. This will damage the oxide skin and could lead to leaks in the system as a result of pitting corrosion.**

▢ If required, clean the following components:

- the pilot flame burner;
- the combustion room;
- the panes.

**!Caution** Only clean a glass pane once it has reached room temperature.

**!Caution** - Avoid damage to the glass pane(s).

- Avoid/remove fingerprints on the glass pane(s), as they will burn into the glass.
- Clean the glass pane(s) as described in the user manual.
- Regularly remove accumulated dirt, as it can burn into the glass.
- Do not use the appliance when a glass pane is broken and/or cracked, until it has been replaced as described from section 6.9



**Caution**

- If necessary, place back the wood set correctly; see section 6.8.

▢ Inspect the flue gas discharge / combustion air supply system;

**!Caution** You must always perform a final inspection.

▢ Perform a check as described in chapter 8.

Parts requiring replacement can be obtained from your supplier.

## 10 Delivery

You must explain to the user how he should operate the appliance. You should instruct her/him for instance on using the appliance for the first time, the operation of the remote control, annual maintenance.



**Caution**

- Tell the user to close the gas tap immediately in case of malfunctions/bad performance and contact the installer in order to prevent dangerous situations;
- Indicate the location of the gas tap;
- Point out the precautions in the user manual against unintended ignition by other wireless remote controls such as car keys and garage door openers.

▢ Instruct the user about the appliance and the remote control.

▢ When the appliance is started for the first time, point out that

- when the appliance is stoked up for the first time, volatile components evaporate from paint, materials, etc.;
- when evaporating the appliance should preferably be set at the highest level;
- the room should be well ventilated.

▢ Give the user manual and installation manual to the user (the installation manual should be kept near the appliance).

## 11. Storingen

### Malfunction search diagram atmospheric gas-fired heating appliance with electronic ignition: Starting up cycle.

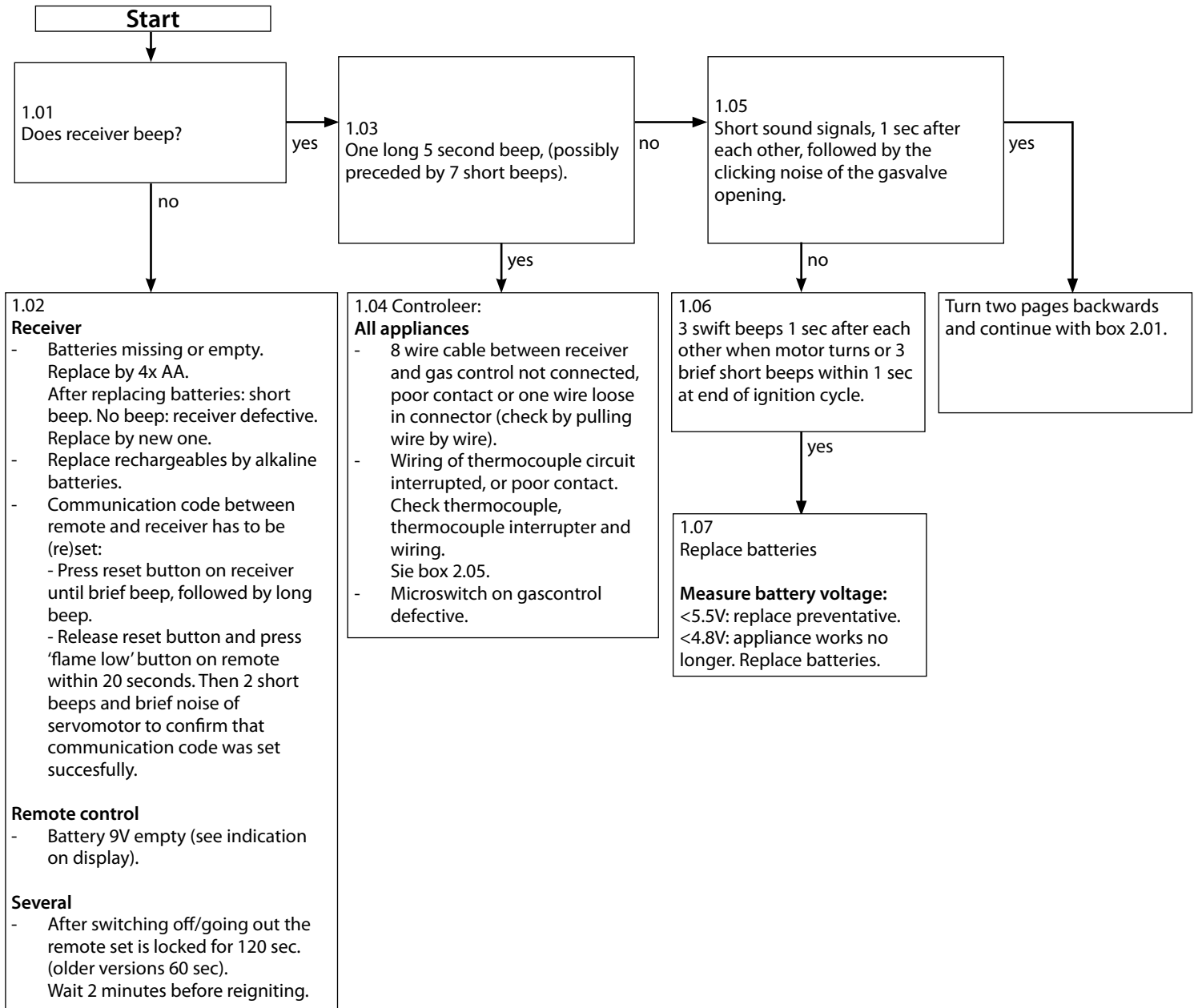

## Fires with electronic ignition, fault finding: Ignition and burning

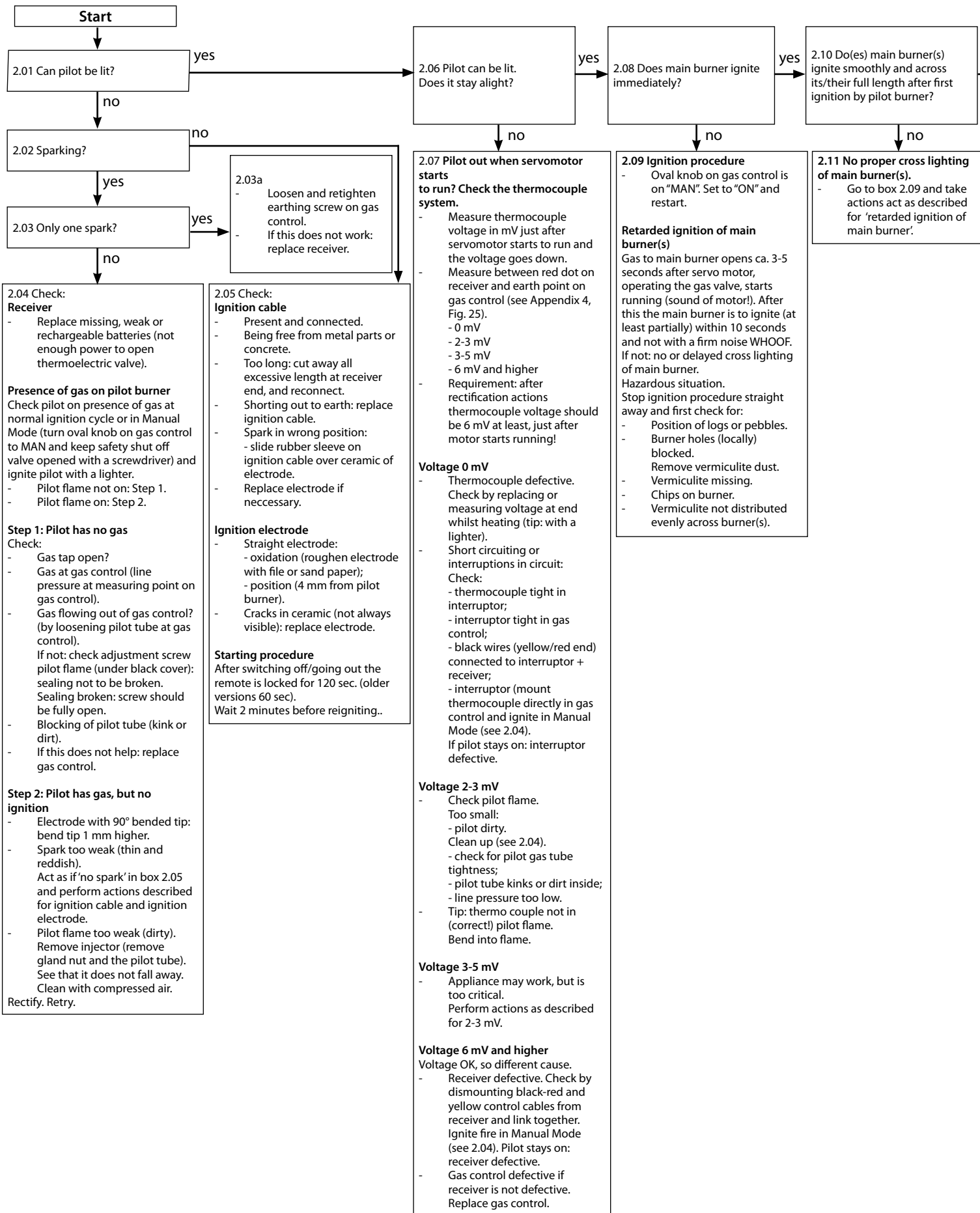



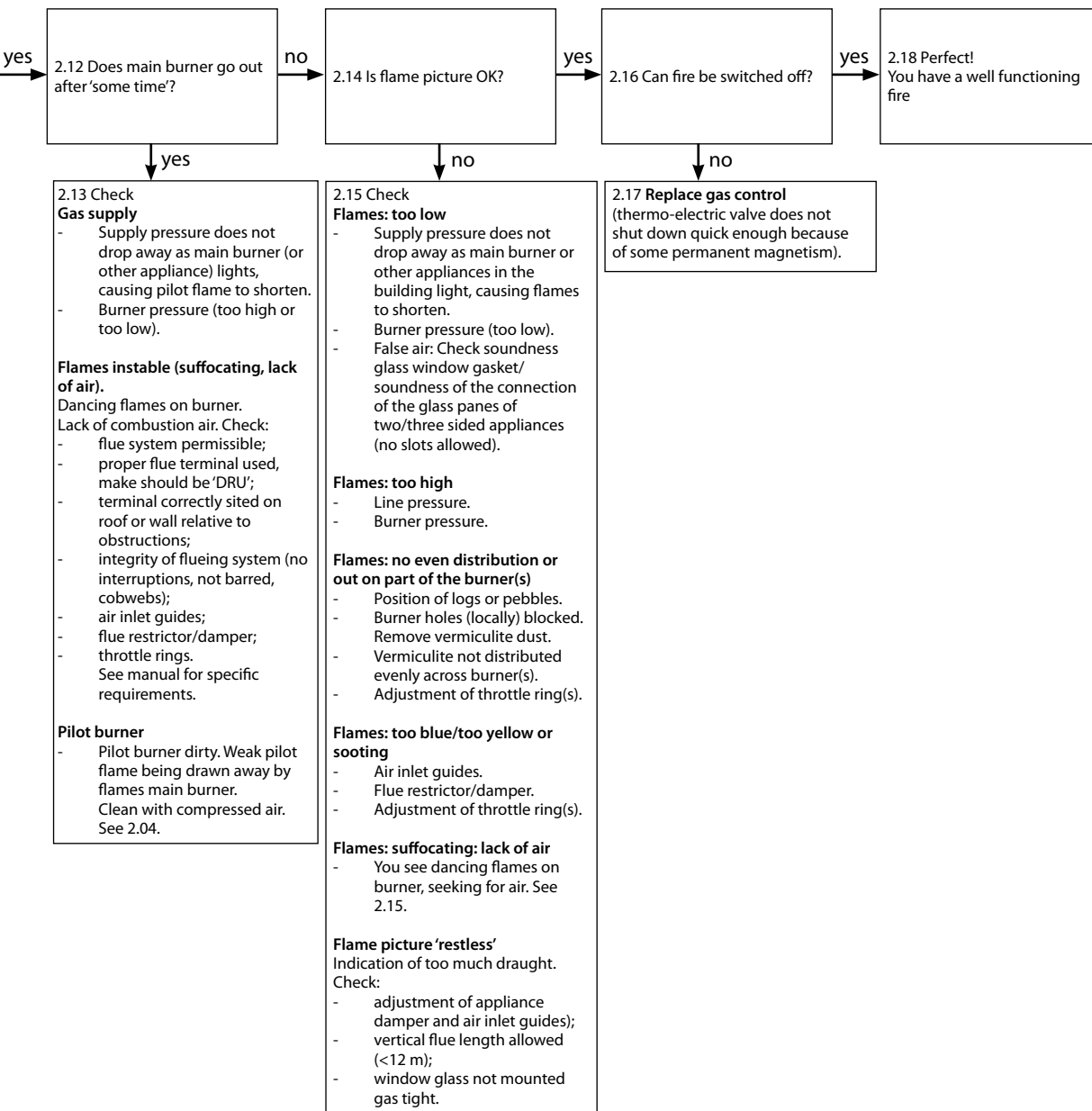

## Appendix 1 Parts included with the delivery

In the following table you can find the parts that are supplied with the appliance.

Table 5: Parts included with the delivery	
Part	Quantity
Wood set	1x
Installation manual	1x
User manual	1x
Setting template for baffle	1x
Baffle	1x
Air inlet guide	1x
Spare parkers for mounting the front pane	
Socket spanner	1x
Remote control with receiver	1x
9V block battery	1x
Penlite battery (AA type)	4x
Squeeze coupling 15 mm x G3/8"	1x

## Appendix 2 Technical data

In the following table you can find the technical data.

Table 6: Technical data					
Model identifier(s):	Trio RCE				
Type of appliance	Free-standing				
Combustion	Closed combustion				
Type	C11, C31, C91				
Category	$I_{2EK}, I_{2ELL}, I_{2H}, I_{2E+}, I_{2E}$				
Concentric appliance connection	150/100				
Applicable concentric systems	DRU LAS ES-E 200/150/100 DRU LAS ES-I 150/100, DRU LAS AG-I 150/100				
Flame protection version	Pilot flame with thermocouple				
2nd thermocouple safety	Yes				
Atmosphere safety	No				
Explosion hatch	Yes				
Gastype	Symbol	G25,3*	G25 20mbar	G20	Unit
Indirect heating functionality		No	No	No	
Direct heat output		4,2	3,7	4,5	kW
Indirect heat output		-	-	-	kW
Space heating emissions NO <sub>x</sub>		99,0	99,0	90,2	mg/kWh <sub>input</sub> (GCV)
Heat output					
Nominal heat output	$P_{nom}$	4,2	3,7	4,5	kW
Minimum heat output (indicative)	$P_{min}$	1,8	1,8	2,0	kW
Technical data					
Nominal heat input (Hs)		6,0	5,4	6,6	kW
Nominal heat input (Hi)		5,4	4,9	5,9	kW
Consumption max		658,0	581	620,0	L/h
Consumption min		380,0	402	355,0	L/h
Burner pressure max		24,5	19,5	19,5	mbar
Burner pressure min		8,1	8,1	6,7	mbar
Main burner injector		1x Ø1,20 1x Ø1,40	1x Ø1,20 1x Ø1,40	1x Ø1,20 1x Ø1,40	mm
Low setting injector		1,6	1,6	1,6	mm
Efficiency class (EN613)		2	2	2	
Useful efficiency (NCV)					
Useful efficiency at nominal heat output	$\eta_{th,nom}$	87,4	87,4	85,4	%
Useful efficiency at minimum heat output (indicative)	$\eta_{th,min}$	81,7	81,7	83,0	%
Auxiliary electricity consumption					
At nominal heat output	$e_{max}$	-	-	-	kW
At nominal heat output	$e_{min}$	-	-	-	kW
In standby mode	$e_{SB}$	-	-	-	kW
Permanent pilot flame power requirement					
Pilot flame power requirement (if applicable)	$P_{pilot}$	-	-	-	kW
Energy efficiency					
Energy efficiency index	EEL	87	87	85	
Energy efficiency class		B	B	B	
Type of heat output / room temperature control					
Single stage heat output, no room temperature control					No
Two or more manual stages, no room temperature control					No
With mechanic thermostat room temperature control					No
With electronic room temperature control					Yes
With electronic room temperature control plus day timer					Yes
With electronic room temperature control plus week timer					Yes***
Other control options					
Room temperature control, with presence detection					Yes***
Room temperature control, with open window detection					Yes***
With distance controle option					Yes***

\* This appliance is suitable for G25,3 with the composition according NTA 8837.

\*\* System efficiency

\*\*\* Is applicable using domotics.

## Appendix 3 Parts

Parts can be ordered through [www.druservice.nl](http://www.druservice.nl)

Appendix 4 Figures

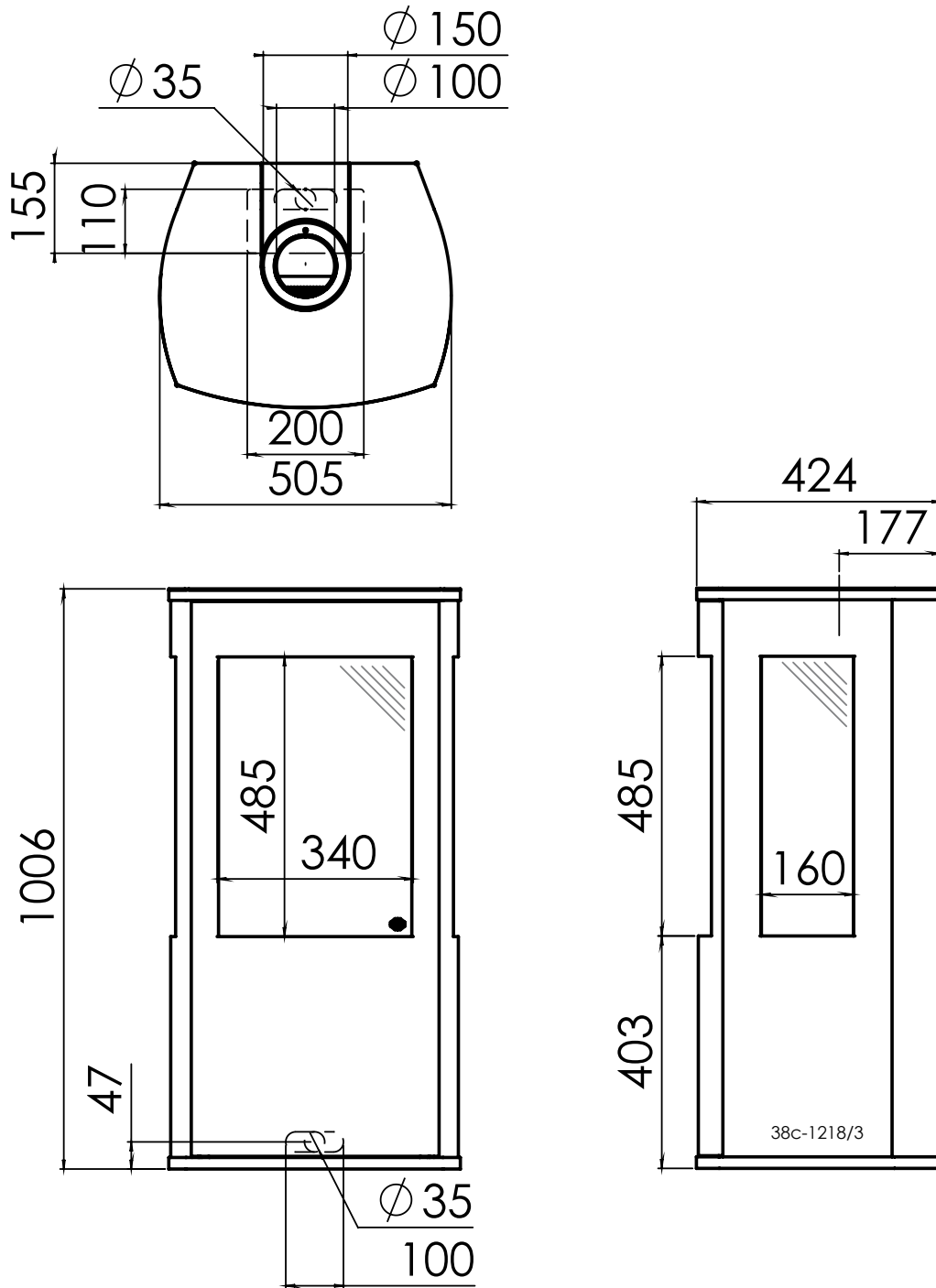
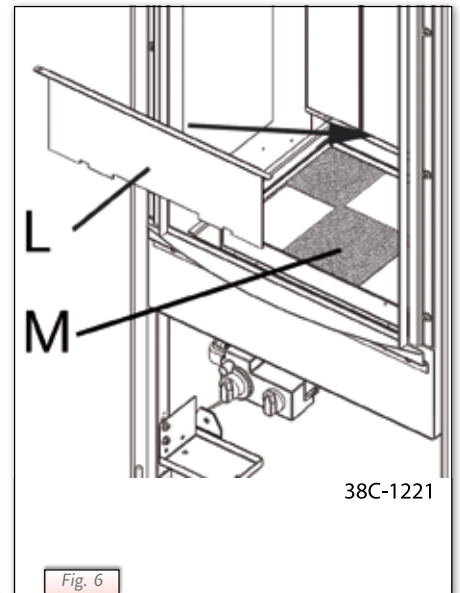
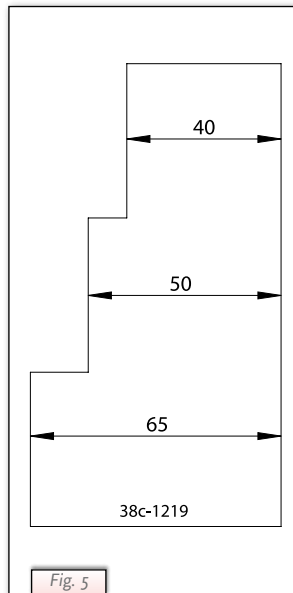
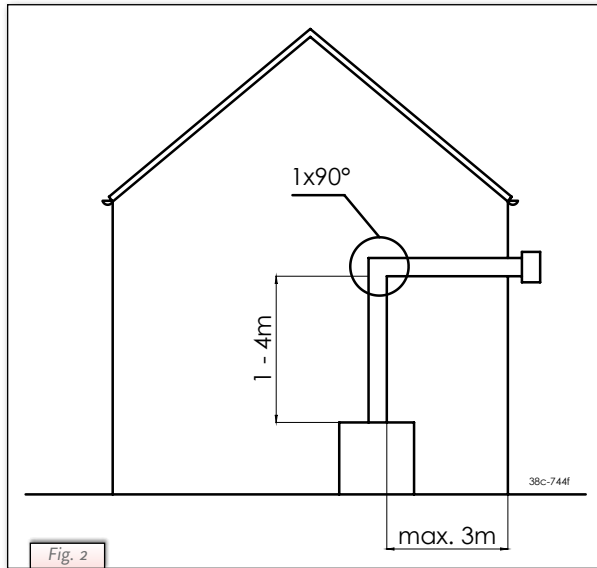
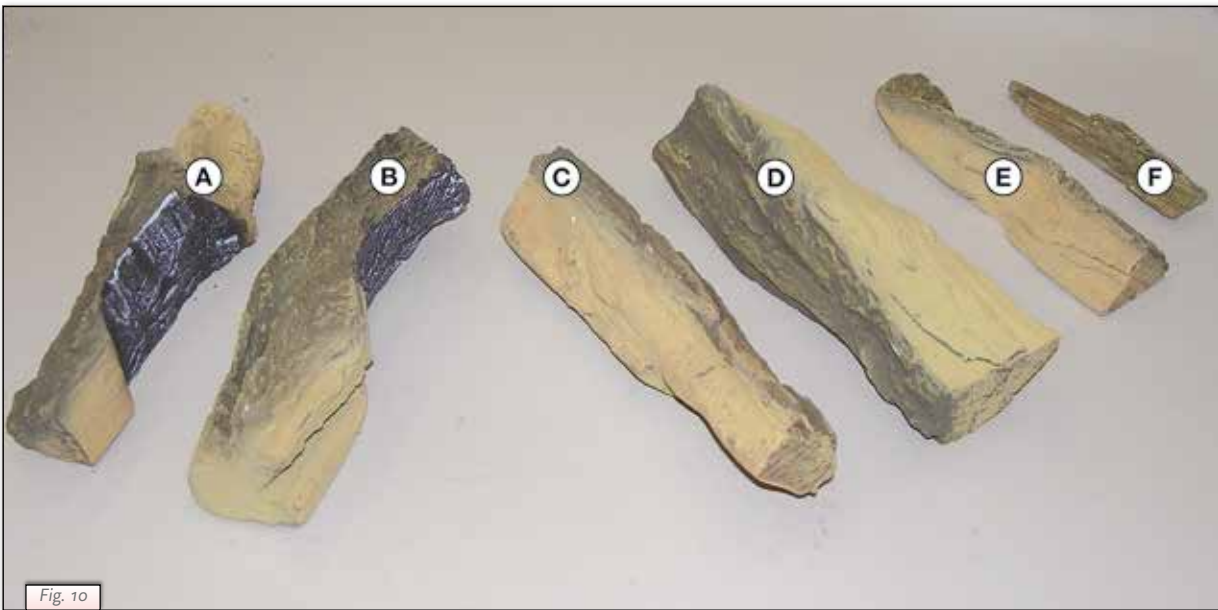
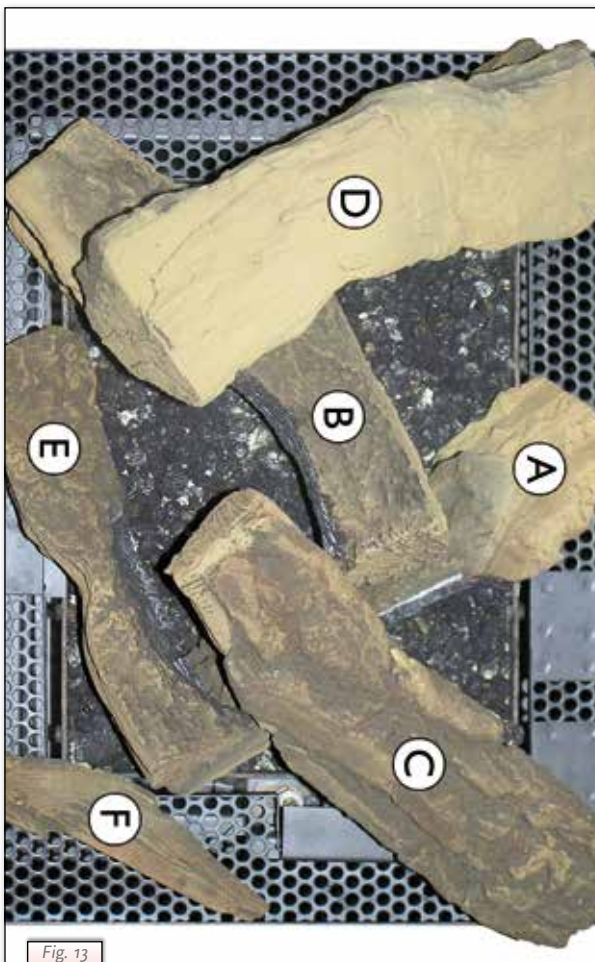
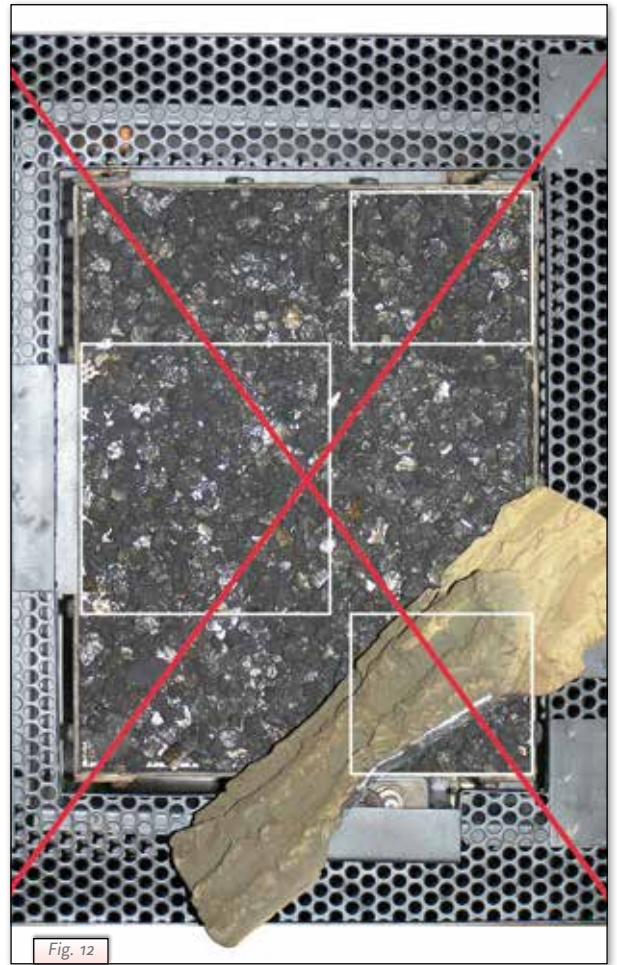
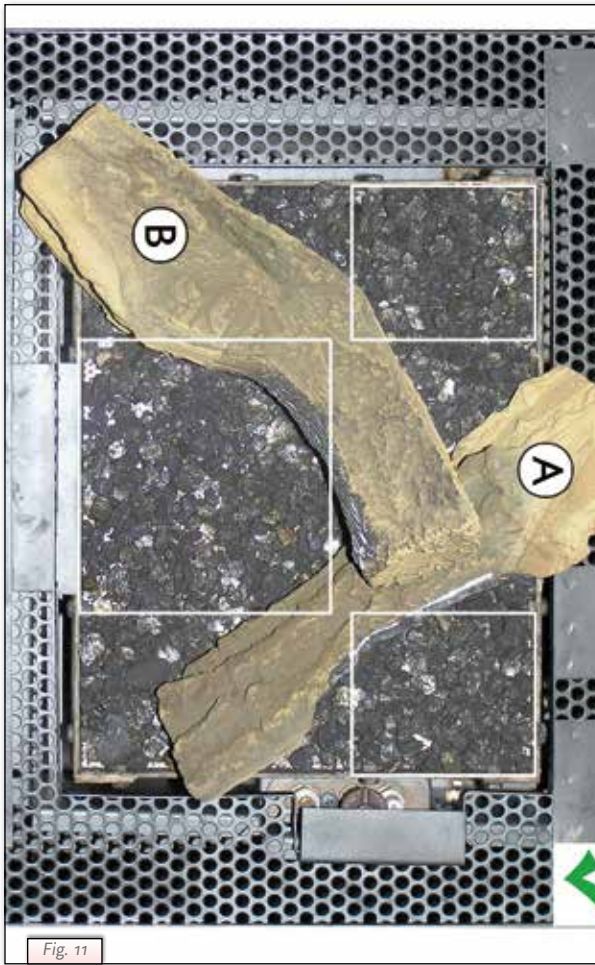

Fig. 1











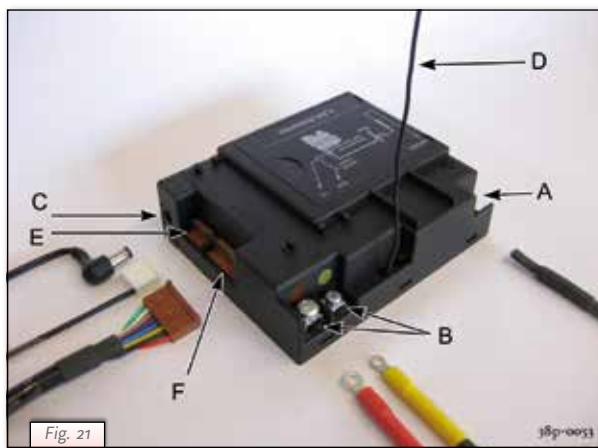
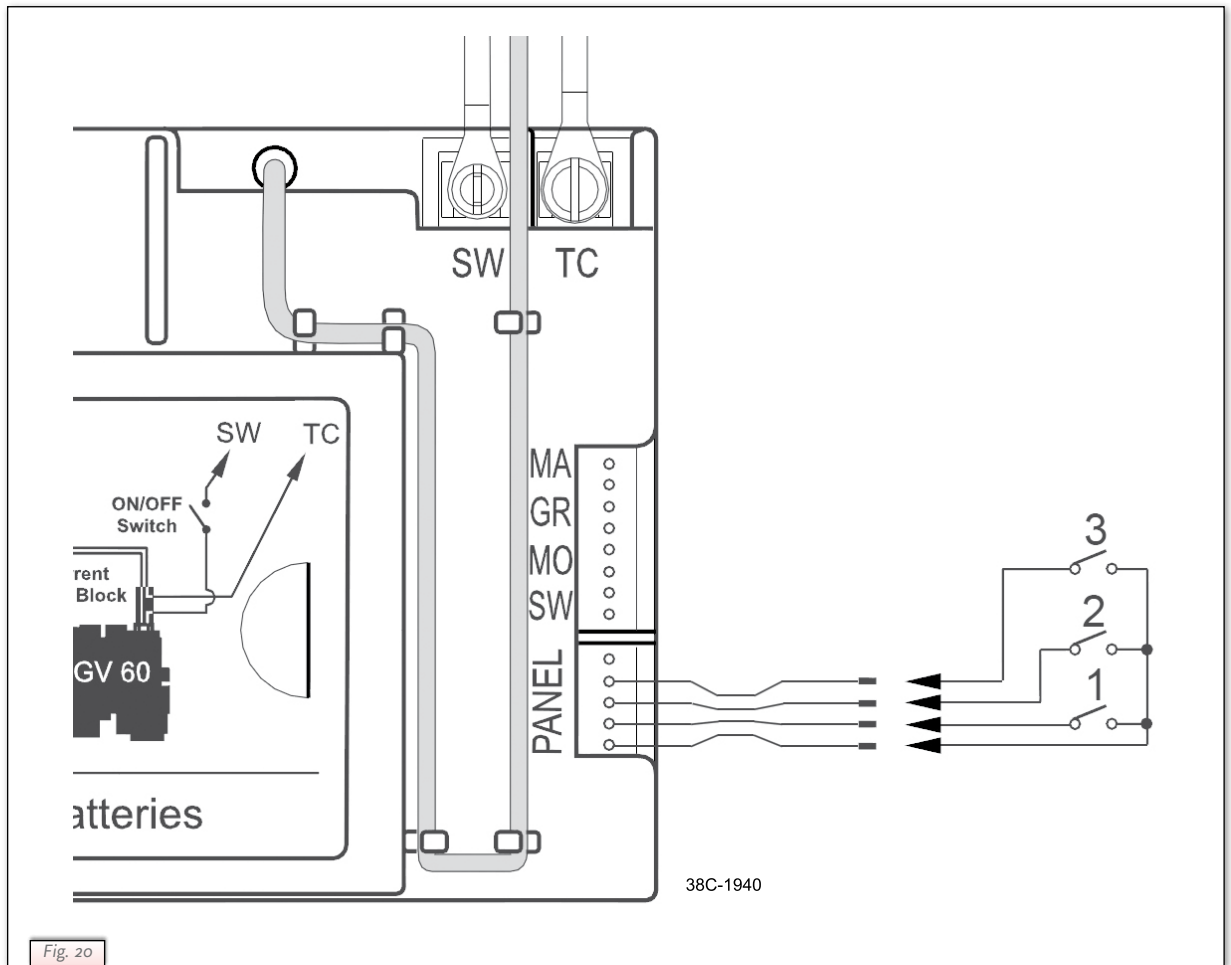

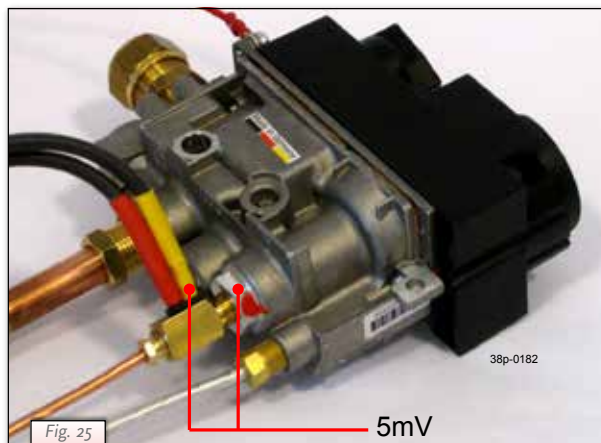
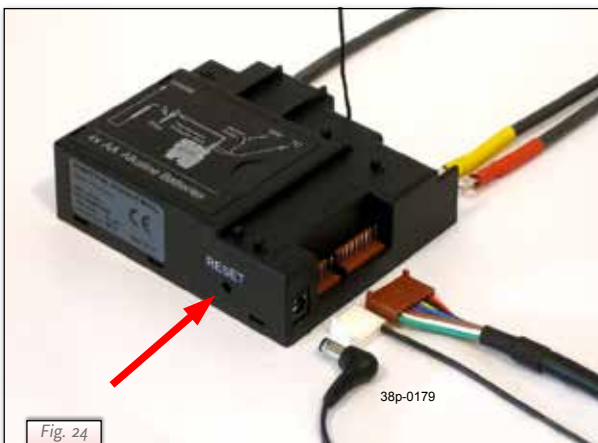
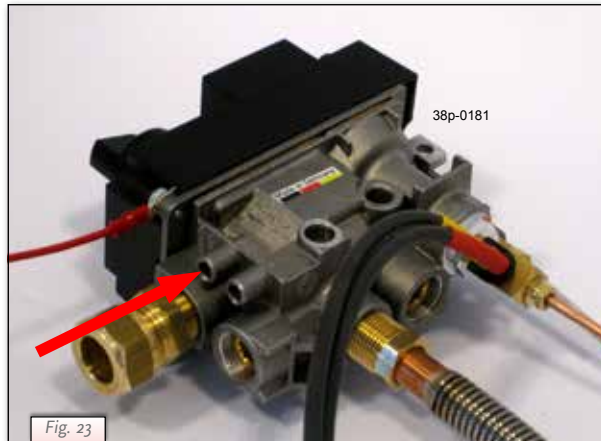
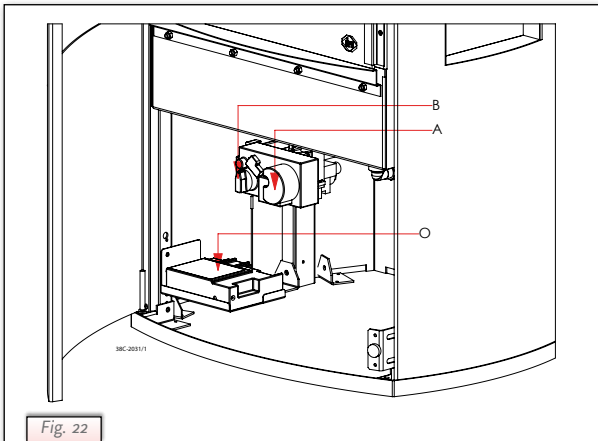



**DRU Verwarming B.V.**  
**The Netherlands**  
Postbus 1021, NL-6920 BA Duiven  
Ratio 8, NL-6921 RW Duiven